

Cylinder-head bolts in practice



Optimal safety:
Cylinder-head gaskets and cylinder-
head bolts from a single source



Das Original



Contents

Page

1	Cylinder-head bracing	6
2	Function	8
3	Bolt types	10
4	Everything revolves around safety and we've got it covered!	12
5	Professional repair	15
6	Quality check	16
7	Technical features	18
8	Packaging	19

Safety isn't a flexible concept

Elring offers the highest level of service

With modern engine generations, correct repair of the cylinder-head gasket joint requires both the cylinder-head gasket and the cylinder-head bolts to be replaced.

With the complete cylinder-head bolt range from Elring, you save both time and money. We offer everything from a single source: the cylinder-head gasket and the matching cylinder-head bolt set

- for practically all passenger cars and commercial vehicles
- in tested quality
- compiled per engine repair
- packaged in a special box with thread protection
- convenient and easy
- directly from the gasket manufacturer



The right approach
for optimal safety



Cylinder-head bolts



Cylinder-head gasket



Cylinder-head repair

100% secure
sealing
and optimal
engine power

Elring cylinder-head bolts are available for:

**ALFA ROMEO | AUDI | BMW | BUICK | CADILLAC
CHEVROLET | CHRYSLER | CITROËN
CUPRA | DACIA | DAEWOO | DAF | DEUTZ | DODGE
DS | FIAT | FORD | GMC | HOLDEN | HONDA
HYUNDAI | ISUZU | IVECO | JAGUAR | JEEP | KIA
LADA | LAND ROVER | LANCIA | MAN
MAZDA | MERCEDES-BENZ | MINI | MITSUBISHI
NISSAN | OLDSMOBILE | OPEL | PEUGEOT
PONTIAC | PORSCHE | RENAULT | ROVER | SAAB
SATURN | SCANIA | SEAT | ŠKODA
SSANGYONG | SUBARU | SUZUKI | TOYOTA
VAUXHALL | VOLKSWAGEN | VOLVO**

Cylinder-head bracing

Secure safety

Cylinder-head bracings with no re-torque are standard in engine construction. This is due to technical and economical aspects in engine production and during assembly in the event of a repair:

- even force on all bolts
- reliable, functioning seal joint
- cost savings

To remove the need for re-torquing, while also achieving reliable cylinder-head bracing, the components involved in the cylinder head sealing joint must be coordinated as early as the development phase in terms of design.

The cylinder-head bolt therefore makes a significant contribution to secure sealing of the sealing joint with its design and the material quality.

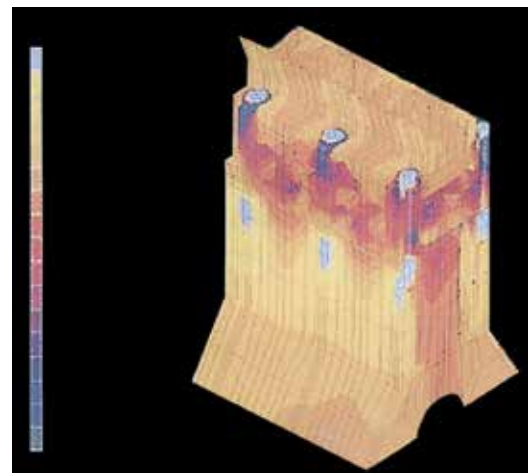

Tensile and compression forces in the cylinder-head sealing joint – made visible with the finite-elements method



The cylinder-head sealing joint

Cylinder-head bolts

Cylinder head

Cylinder-head gasket

Crankcase
Cylinder liner
(depending on the engine design)

Function



Effective forces

Cylinder-head bolts are the construction elements of the cylinder-head sealing joint, which generate the necessary surface pressure and transfer it to the engine components. For this, the cylinder-head bolts must be bolted in with precisely defined tightening procedures and sequences.

The cylinder-head gasket can only distribute the total force available to it to the various areas to be sealed (gas, water and oil sealing). This is referred to as the specific sealing pressure distribution.

So:

The total force generated by the cylinder-head bolts and its even distribution over the entire sealing joint is a key requirement for the function of the cylinder-head gasket.

In order to fulfil the requirements of modern lightweight engine designs, such as

- higher ignition pressures (up to 220 bar)
- increasing relative movement of the engine components
- reducing engine rigidity and higher thermal component expansions due to the aluminium-magnesium design
- reduced warping of cylinder bores and cylinder head (reduced bolt forces)

the cylinder-head bolt has also undergone significant changes in the field of engine construction over the past decades. Their properties must correspond to the engine requirements down to the smallest detail.

In addition to the improved materials and production processes of the bolts, key changes took place in

- the bolt design
- the tightening procedure

The surface coatings of the bolts have also been developed further to achieve improved friction parameters.

Bolt types

The first choice for lightweight engines

Lightweight engine constructions such as

- cylinder head made from aluminium and crankcase from grey cast iron
- cylinder head and crankcase made from aluminium

have a different thermal expansion characteristics compared with steel cylinder-head bolts. The thermal expansion of the aluminium engine components is around double that of the cylinder-head bolts.

The use of lightweight materials for engine components and the changed tightening procedures are the reasons why the following bolt geometries are primarily used for cylinder-head bracing today:

Roll shaft bolts.

Used primarily in passenger cars. With roll shaft bolts, the thread is rolled on to the shaft. The bolt undergoes no further machining. The elastic properties of the roll shaft bolt with long thread are extremely similar to the expansion shaft bolt that has to be machined. This is why it is referred to as a low-cost type of "expansion shaft bolt".

Roll shaft bolts with short thread.

With these bolts, the thread is only rolled up to the maximum bolt-in depth. The topmost thread absorbs the highest force and therefore usually undergoes a permanent plastic deformation.



Roll shaft bolts with long thread.

These bolts have an extremely long thread section, which usually reaches to just below the bolt head. The elastic and plastic elongation of the bolt during tightening and in powered engine operation takes place in this area. The version with a long thread increases the elasticity, ensures even tension along the shaft and gives the bolt a sufficient plastic deformation capacity. This guarantees the long-term durability of the entire cylinder-head sealing joint.



Expansion coil bolts.

These are bolts with a course single or multiple thread rolled into the shaft as an "expansion coil". Here to, the "expansion coil" increases the elasticity and ensures even tension distribution. The elastic flexibility of the expansion coil bolt depends on the core diameter of the expansion coil profile chosen: The smaller the diameter, the closer it comes to the characteristic of an expansion shaft bolt.

Expansion shaft bolts (tapered shaft bolts).

This bolt design is often used in commercial vehicle engines and is characterised by a tapered shaft from the thread to just below the bolt head. Due to the smaller cross-section compared with full shaft bolts, a larger elastic and plastic flexibility is achieved. The plastic elongation relevant for repairs takes place in the bevelled part of the bolt shaft that is not bolted in.



Everything revolves around safety and we've got it covered!

The right approach for increased safety

In cooperation between engine manufacturers and the supplier industry, extensive testing and development programmes were carried out to use improved engine components and technologies such as

- "Metaloflex" cylinder-head gaskets with a high sealing potential and lower setting behaviour
- cylinder-head bolts with special plastic deformation characteristics
- new tightening processes for cylinder-head bolts to achieve significantly improved sealing joints that guarantee a reliable seal, particularly over the long-term.

Bolt tightening with torque

In the past, the cylinder-head bolts were tightened with a precisely defined torque in several stages in the elastic expansion range of the bolt material (outer left figure).

Special features of torque tightening:

1. When applying the tightening torque M_A , bolt force fluctuations in the preload force F_V of $\pm 20\%$ occur due to the different head friction (M_K) and thread friction torques (M_G) (left centre figure). Even distribution of the pressure over the entire seal could not be achieved with this approach.
2. As a result of cold static setting processes of the soft-material gasket after installation (= loss of preload force) and a further reduction in pressure in powered engine operation, the bolts had to be tightened after a specific engine runtime. Tightening the cylinder-head bolts did not resolve the issue with the spread of the bolt forces, however.

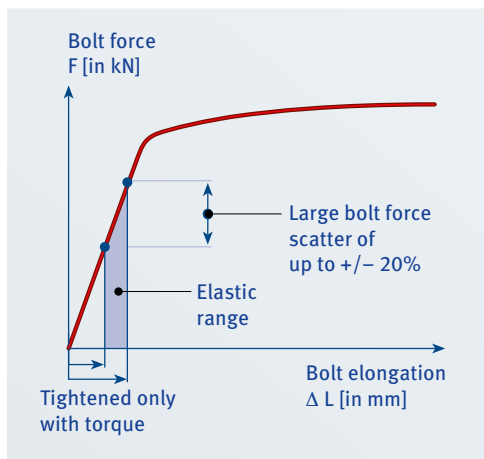

Elastic bolt tightening

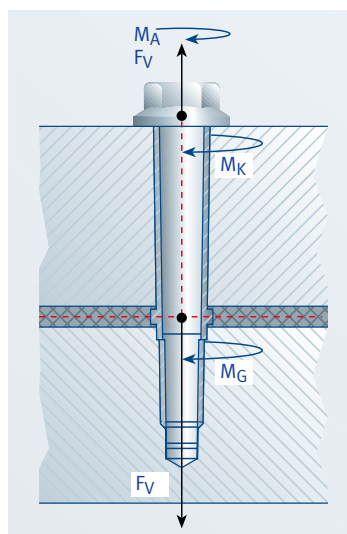

Forces and torques during tightening



Bolt tightening with torque and rotation angle for the latest engine generations

With this process, the cylinder-head bolt is not only expanded elastically, but also elongated plastically, which offers significant advantages compared with bolt tightening with torque.

Description of the combined process.

With the torque-rotation angle procedure, the bolt is tightened with a defined low torque in the elastic range of the bolt characteristic curve in the first step (bottom figure).

Following the torque tightening, further tightening takes place by a specific rotation angle. During this process, the bolt material is plastically deformed beyond the yield strength (that marks the transition from the elastic to the plastic range).

Advantage of rotation-angle tightening:

1. This tightening procedure, in conjunction with the new bolt versions, can reduce the spread range of the bolt preload force significantly. The rotation angle is not applied with a larger preload force, but merely through plastic bolt elongation. This achieves an even bolt force level across all cylinder-head bolts – an important requirement for achieving leak-tightness over the entire join.
2. There is no need to re-righten the cylinder-head bolts. Metal layer gaskets make it even easier to do without retightening, as only low setting values occur here. The remaining bolt force fluctuations can be traced back to dimensional production tolerances of the bolts and strength tolerances of the material.

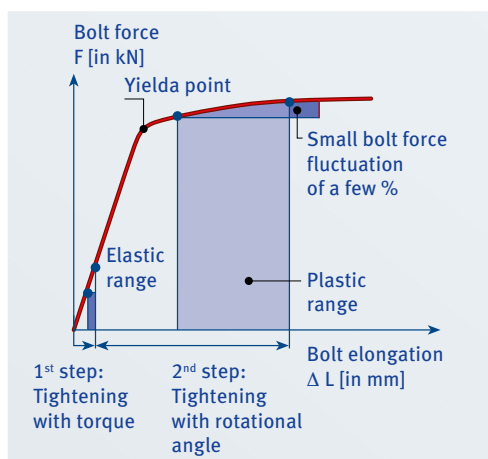

Plastic bolt tightening

Tightening sequence

The cylinder-head bolts (e.g. 1 – 10 with the 4-cylinder engine; bottom figure) must be bolted in according to precisely defined tightening sequences (see manufacturer information). Like the tightening torques and tightening angles, these are specified by the engine and gasket manufacturers and are adapted to the relevant engine design. Every cylinder-head gasket and every gasket set from Elring comes with engine-specific tightening specifications in multiple languages.

The bolt tightening should take place in several increments and the individual steps could be as follows:

- 1st step 20 Nm (i.e. tighten bolts 1 – 10 with tightening torque 20 Nm)
- 2nd step 60 Nm (i.e. tighten bolts 1-10 with tightening torque 60 Nm)
- 3rd step 90° (i.e. tighten bolts 1 – 10 with tightening angle 90°)
- 4th step 90° (i.e. tighten bolts 1 – 10 again with tightening angle 90°)

The following rules applies to each tightening sequence:

The individual steps of the bolt tightening always start in the centre of the engine (between cyl. 2 and cyl. 3; see example) and continue in spiral form or crosswise to both sides to the outer bolts of cyl. 1 and cyl. 4.

This ensures that the cylinder head and the cylinder-head gasket are optimally braced with the crankcase.

If the specifications are not observed, unwanted tensions and warping occur on the engine components.
The result: leaks can occur in the cylinder-head gasket join

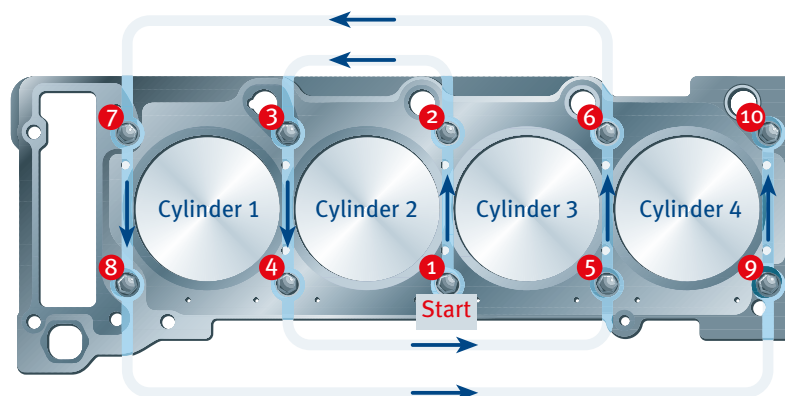

Tightening sequence for cylinder head (example)

Professional repair

Only new cylinder-head bolts are 100 % secure

The current engine generations have improved sealing concepts-adapted to the engine design. The function of the cylinder-head bolts plays a key role here.

The cylinder-head bolts can be elongated plastically compared with the original state due to

- the new tightening process with torque plus rotation angle (= plastic elongation of the bolt) and
- the modern engine designs, e.g. aluminium-aluminium pairing (= additional plastic elongation during the first heat-up of the engine) by several millimetres.

In addition to changes in the strength and expansion properties of the bolt material, the elongation of the bolt also reduces the cross-section. If this bolt is reused, there is a risk that the applied bolt force can no longer be absorbed by the reduced cross-section. This results in bolt breakage.

Tests show: With a M10 bolt of medium strength 10.9, the load capacity can reduce by 10 – 15 % if only 0.3 mm of the diameter is lost. I.e. the gasket is pressed with insufficient force and can develop leaks after a short time. For professional repair of the cylinder-head gasket, the specification of the engine and gasket manufacturer must therefore be observed:

- always use new cylinder-head bolts and a new cylinder-head gasket
- observe the tightening torques and tightening angle
- observe the tightening sequence
- use torsion-free, clean engine components
- installation must only be carried out by trained specialist personnel
- use quality tools

Optimal tensioning and a functional seal can only be achieved if this specification is observed. Bolts that have already been used and plastically elongated must not be reused. This helps to prevent possible consequential damage such as leaks and the various resulting repair costs, angry customers and damage to image.



Plastically elongated and bevelled cylinder-head bolt

Quality check

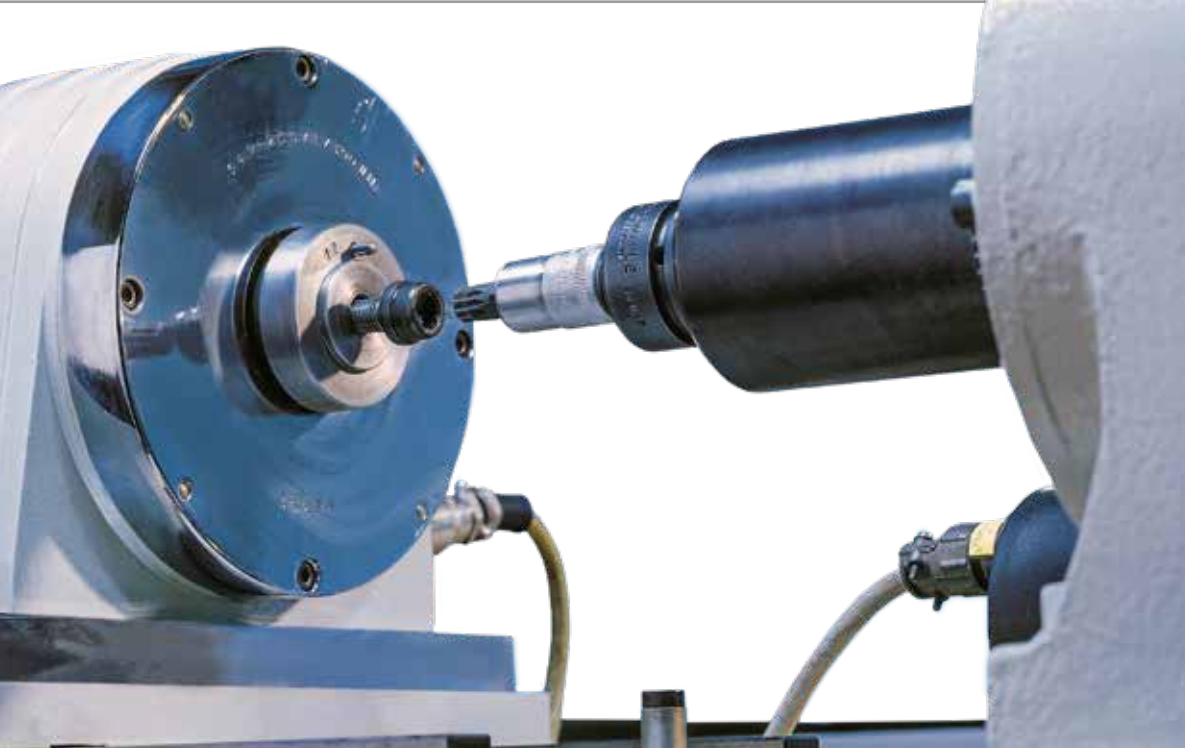

Bolt test bench – the reliable test to determine the bolt characteristic curve

Tested safety

Every engine prototype places specific requirements on the cylinder-head bolts, which must be observed to guarantee the function of the entire seal joint.

This is why the relevant drawings, initial sample test reports and various forms of chemical and dimensional evidence are checked comprehensively for each bolt type.

Additional measurements carried out on a bolt test bench before approval guarantee the quality standard.

Creation of a bolt characteristic curve on the bolt test bench

During the test, the bolt is tightened beyond the specified tightening procedure (here tightening torque 60 Nm + rotation angle 180°) to achieve a detailed and clear bolt characteristic curve. The characteristic curve recorded during tightening is assessed based on the following criteria:

1. The bolt force F_1 achieved after tightening with the specified torque and rotation angle (here 60 Nm + 180°) must be within a defined force range between the minimum and maximum force (10 N ~ 1 kg).
2. After a specific torque is applied (here 70 Nm), it must be possible to turn the bolt by at least 2 further rotations ($\pm 90^\circ$ rotation angle, manufacturer-dependent). The bolt force must not reduce significantly.
3. The difference in the measured maximum force F_{\max} and the force after tightening F_1 must be greater than the value specified by the manufacturer (here 4000 N).

4. The bolt characteristic curve (red-yellow) must follow the course shown here during tightening. There must be no jumps or other deviations.

The fulfilment of these four key criteria on the bolt test bench and the accompanying reports on the dimension and chemical consistency ensure that the tested bolt type has the potential to seal the engine reliably.

To round off the characteristic curve, the permanent elongation of the bolt after removal from the test bench is visible in the bottom left-hand corner of the diagram. When the bolt is loosened, the characteristic curve moves from the value F_1 downwards along the red dotted line. The red line must then be compared with the remaining elongation of the bolt after removal.

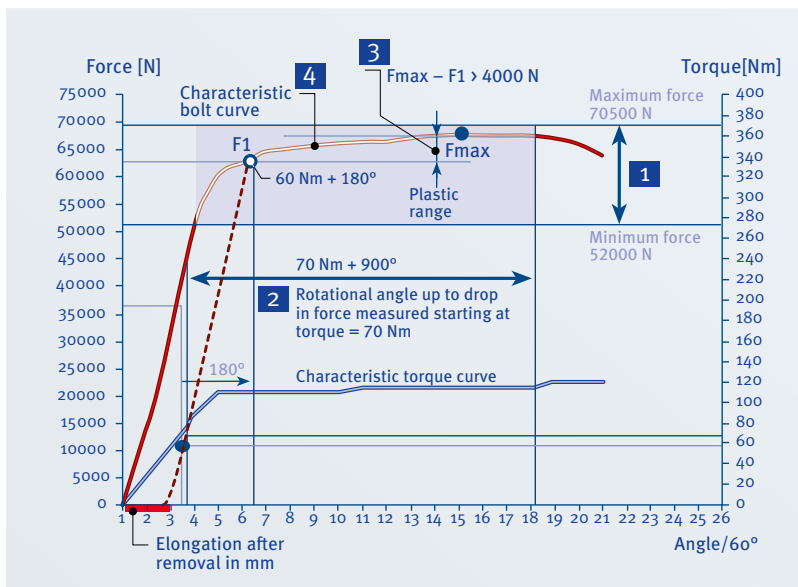

Bolt characteristic curve

Technical features

Example:

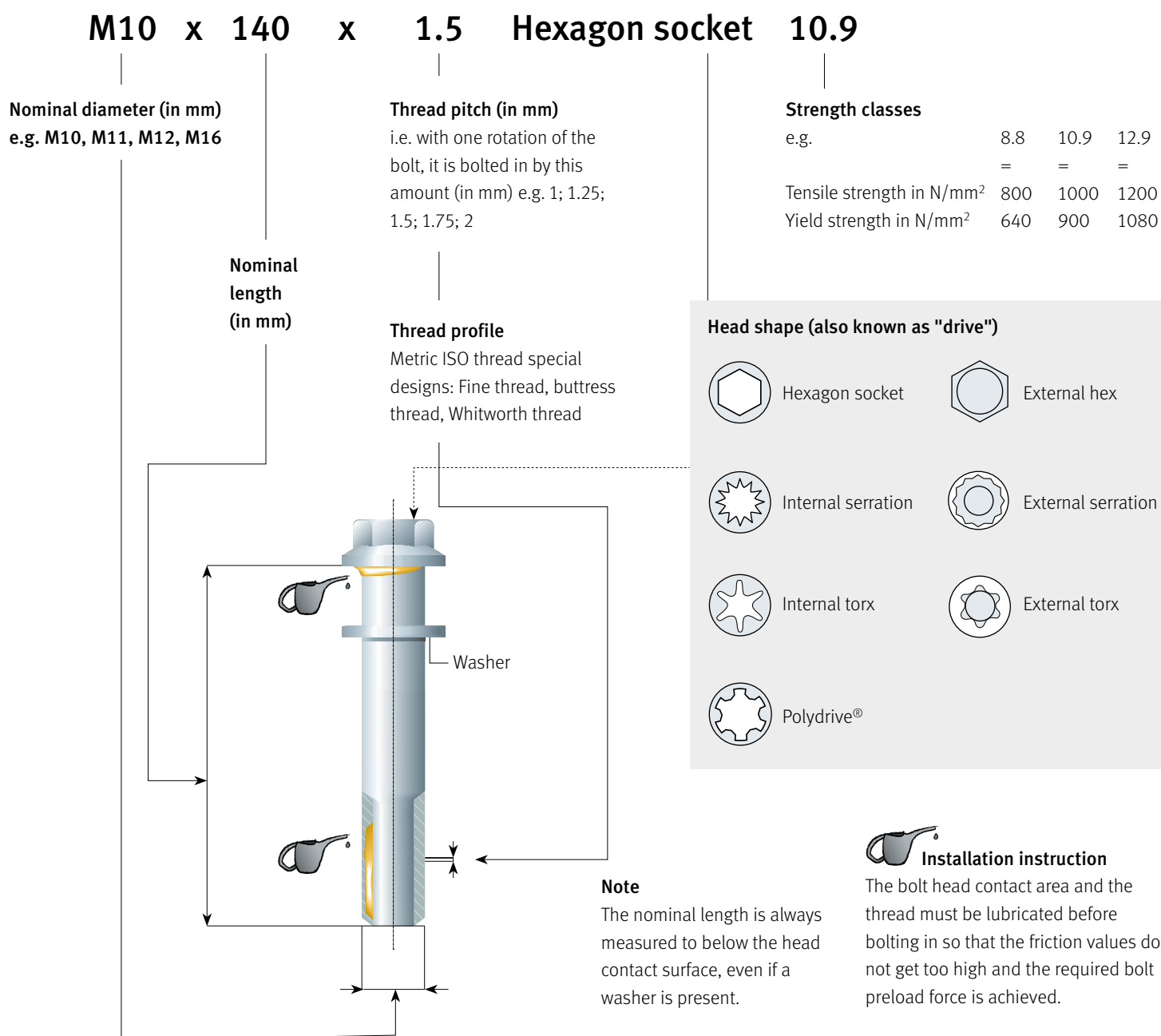

Packaging



Cylinder-head bolts – arriving safely

We place great importance on ensuring that our cylinder-head bolts arrive at our customers in tested quality, securely packaged for transport and free from damage. The cylinder-head bolts are therefore compiled to suit the specific engine and packaged in environmentally-friendly folding boxes. Individual box dividers also enable approx. 95 % of the over 200 bolt types with a wide range of lengths and diameters to be packaged economically in one folding box size. This makes storage significantly easier.

This packaging solution enables us to optimize the protection and logistics functions and ensure that the bolts match the required function and the expectations of our customers.

Ensuring a reliable supply to our customers with identical product quality and outstanding service around the world is part of our corporate philosophy – and the basis for a long-term and constructive cooperation with our customers.



The information provided here – based on years of experience and findings – is not intended to be comprehensive. Any claims for compensation based on this information excluded. All spare parts may only be installed by trained specialist personnel. Changes to the range and technical changes reserved. No liability for printing errors.

ElringKlinger AG | Aftermarket Division
Max-Eyth-Straße 2 | D-72581 Dettingen/Erms
Tél. +49 7123 724-799 | Fax +49 7123 724-798
elring@elring.de | www.elring.com

C510288 0522 EN



Das Original